





Inhaltsverzeichnis

Collection Modern	4 – 9
Collection Classic	10 – 13
Collection Prestige	14 – 19
Collection Lighting	20 – 21
Collection Rosetten	22 – 25
Collection Pilaster	26 – 27
Collection Säulen & Halbsäulen	28 – 31
Collection Verblendsteine	32 – 33
Collection Balken & Bretter	34 – 37
Collection Deckenplatten	38 – 39
Collection Dämmtapeten	40
Zubehör	41
Marketing	42 – 43

Identität mit dem Produkt in allen Abteilungen

Unsere Unternehmensgeschichte hat eine lange Tradition. **Erfahrungswerte und Kompetenzen** wurden so über viele Jahre hinweg durch die Firma getragen, nach außen kommuniziert und nach innen gelebt. So konnten wir uns auf die wichtigsten Dinge konzentrieren und stellen Tag für Tag unsere Kernwerte **Qualität, Respekt und Vertrauen** in den Vordergrund unseres Handelns. Dabei ist es für uns sehr wichtig, dass wir diese Grundsätze in allen Unternehmensrichtungen verinnerlichen. Unsere Lieferanten, Händler und Geschäftspartner sind uns im gleichen Maße wichtig, wie unsere Kunden und Mitarbeiter. So stellen **Transparenz und Verantwortung**, auch gegenüber der Natur, wichtige Basis-Pfeiler für unser tägliches Handeln.

Vielfältige Verantwortung

Zugleich haben wir immer das große Ganze im Blick. Wir bekennen uns zu den Prinzipien des leistungs-, wachstums-, und innovationsorientierten Wirtschaftens mit Verantwortung für Gesellschaft und Umwelt.

Unsere **Ziele und Strategien werden durch unser ökologisches und soziales Bewusstsein** und durch die Verpflichtung zu anspruchsvollem und verantwortungsbewusstem Handeln angetrieben. Geschäftsleitung und Belegschaft handeln nach international anerkannten Leitsätzen – und selbstverständlich im Rahmen aller geltenden Gesetze und Vorschriften.

Unser Qualitätsversprechen an Sie

Qualität ist für uns weit mehr als nur eine Produkteigenschaft oder ein Verkaufsargument – es ist der Maßstab, an dem wir unsere gesamte Arbeit ausrichten. Sämtliche Prozesse bei SachEx unterliegen einer strengen und lückenlosen Qualitätsüberwachung.

Selbstverständlich sind unsere Qualitätskontrollen beim Einkauf der Rohmaterialien und in der Produktion besonders

streng. Jeder einzelne Arbeitsschritt orientiert sich an derselben Frage: Trägt dieser Schritt zu einem optimalen Produkt und zur Kundenzufriedenheit bei? Nur wenn die Antwort ein glasklares „ja“ ist, wird es auch so gemacht.

Dasselbe gilt für die Lagerung und Logistik, für die Zusammenarbeit mit dem Handel und dem Handwerk und nicht zuletzt für den Kundendienst.

Man könnte es auch so sagen: **Wir produzieren Qualität nicht nur – wir leben sie.**

Wir agieren für Sie weltweit! Mit Sitz im Erzgebirge in Sachsen, Deutschland, liefern wir unsere Produkte in weite Teile der EU und drüber hinaus.

Vom Erzgebirge in über 40 Länder

Unsere benachbarten Standorte Geyer und Ehrenfriedersdorf liegen etwa 20 km südlich von Chemnitz im Erzgebirge.

Die Fertigung schöner und nützlicher Dinge hat hier ebenso Tradition wie der Bergbau und die Industrie.

Diese Tradition kommt uns nicht zuletzt bei der Gewinnung neuer Mitarbeiterinnen und Mitarbeiter zugute. Viele Menschen in dieser Region haben einen ausgeprägten Sinn für Technik und Schönheit – und sie sind es gewohnt konzentriert und zielorientiert zu arbeiten.

Kein Wunder also, dass sich die Produkte mit unserem Markenzeichen HOMESTAR® in mittlerweile **mehr als 40 Ländern** großer Beliebtheit erfreuen.

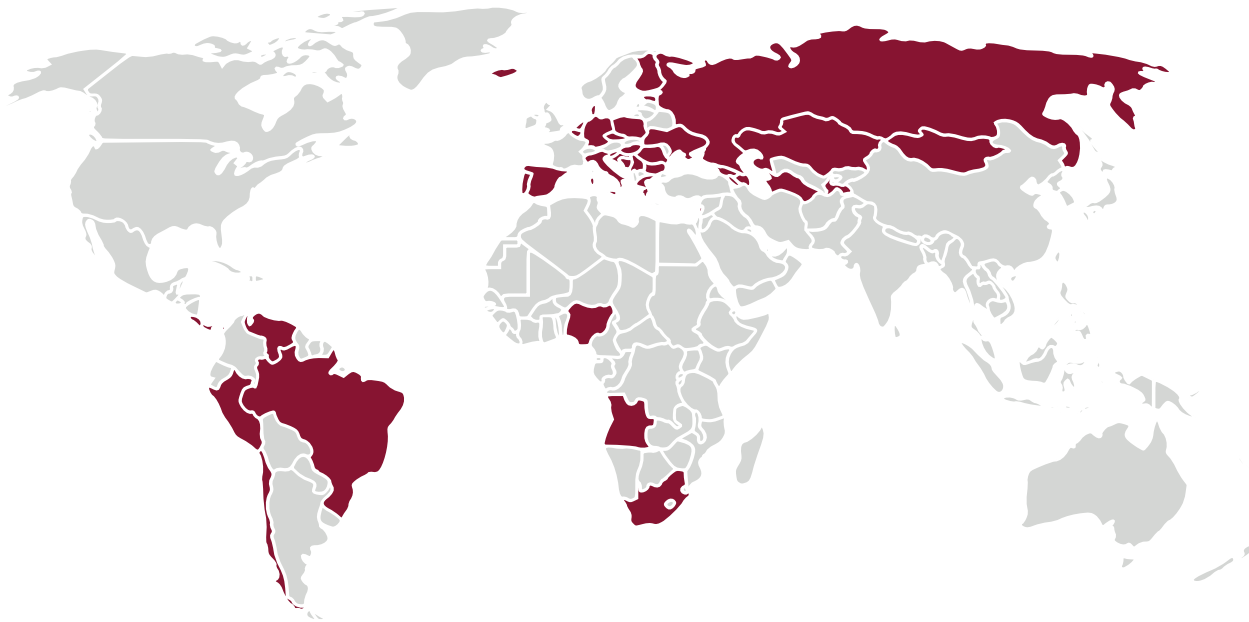

Angola	Griechenland	Portugal
Armenien	Italien	Rumänien
Aserbaidtschan	Island	Russland
Belgien	Israel	Serbien
Bosnien	Kasachstan	Spanien
Brasilien	Kosovo	Südafrika
Bulgarien	Kroatien	Tadschikistan
Chile	Mongolai	Tschechien
Costa Rica	Montenegro	Turkmenistan
Dänemark	Niederlande	Ukraine
Deutschland	Nigeria	Ungarn
Estland	Panama	Venezuela
Finnland	Peru	Zypern
Georgien	Polen	

We relate to our products in all departments

Our company has a long history. Over the years, we have gained **experience and expertise** that we communicated to both business partners and employees. So we could focus on our core values: **Quality, Respect and Trust** - day after day. We take these values seriously and use them to guide our work with suppliers, retailers, business partners as well as clients and employees. Our daily work is based on **transparency and responsibility** - also for the environment.

Diverse Responsibility

At the same time we always see the big picture. We work along with principles that are geared to performance, growth and innovation within the realms of responsible economic activity for the society and environment.

We are driven **by our ecological and social awareness** and by our pledge to ambitious and responsible action. Our management team and employees act on internationally approved guidelines – and of course according to the law and regulations.

Our quality pledge to you

For us, quality is more than just a word – it’s a standard we apply to our whole work. All proceedings at SachEx are subject to a strict and complete quality control.

Already at product development and design we make great demands on ourselves. After all our trims and mouldings are to be last for a long time. It goes without saying that our quality control while purchasing materials and in the production process is especially strict. Every single step in the production process has to contribute to an optimal product and customer satisfaction.

The same goes with storage and logistics, cooperation with retailers and customer service. We want to make exactly the products that you wish for and that you will enjoy for many years.

You can put it like this: **We not only make quality products – we live them.**

Originated from the Erzgebirge (Ore Mountains) in Saxony, Germany, we deliver our products to European countries and beyond.

From the Erzgebirge to more than 40 countries

Our neighboring sites Geyer and Ehrenfriedersdorf are situated ca. 20 km south of the city of Chemnitz in the Erzgebirge. In this region, the manufacturing of beautiful and useful things has a long tradition – like mining and industry. Here a lot of people admire engineering and beauty. They are used to work tightly focused and targeted.



SachEx Kunststoffverarbeitung GmbH
 Annaberger Straße 36, D-09468 Geyer
 Tel. +49 (0)37346 6938-0, Fax +49 (0)37346 6938-28
 www.sachex.com, homestar@sachex.com

Schlichte Eleganz und
geradliniges Design mit einem
breiten Anwendungsspektrum

Produkteigenschaften:

- druckfest, sehr leicht und einfach zu verarbeiten
- passgenaue Profilkonturen, einwandfreier Anschluss von Wand zur Decke durch konstante Maße
- überstreichbar mit allen lösungsmittelfreien Farben
- frei von Lösungsmitteln und FCKW, umweltfreundlich
- Klebverbrauch: ca. 30 g/m

Simple elegance and straight design
with a wide range of applications

product features:

- pressure-resistant, very easy to handle
- tailor-profile contours, perfect connecting from wall to the ceiling by constant mass
- paintable with all solvent-free paints
- free from solvents and CFC, environmentally friendly
- consumption of glue: ca. 30 g/m

DE Zierleisten extrudiert aus Polystyrol
GB Decorative mouldings extruded from polystyrene
FR Moulures décoratives extrudées en polystyrène
ES Perfiles de adorno extruidos de poliestireno
IT Profili decorativi estrusi in polistirolo
RU Профиль из экструдированного полистирола
PT Sancas extrudidas em poliestireno
PL Listwy dekoracyjne z polistyrenu

CZ Ozdobné lišty z extrudovaného polystyrenu
RS Dekorativna lajsna od ekstrudiranog polistirola
HR Ukrasna letvica od ekstrudiranog polistirena
RO Profilul decorativ de polistiren extrudat
BG Декоративен перваз от екструдирани полистирен
GR Κορνίζες από εξηλασμένη πολυστερίνη
SE Taklister av extruderad polystyrene
AR نيريسيسيلوبيل اقدم نم ةعونصملا زيرافال





S 25 Art.-Nr. 13001  225 pieces
E 1 Art.-Nr. 13201  45 packages
 packed in foil 2 x 2 m



S 35 Art.-Nr. 13003  120 pieces
E 3 Art.-Nr. 13203  30 packages
 packed in foil 2 x 2 m



S 50 Art.-Nr. 13004  72 pieces
E 6 Art.-Nr. 13206  15 packages
 packed in foil 2 x 2 m



S 80 Art.-Nr. 13005  30 pieces
E 5 Art.-Nr. 13205  14 packages
 packed in foil 1 x 2 m

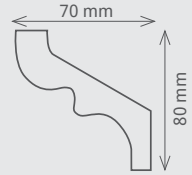

M 35 Art.-Nr. 13035  120 pieces
E 22 Art.-Nr. 13222  30 packages
 packed in foil 2 x 2 m



M 50 Art.-Nr. 13036  90 pieces
E 23 Art.-Nr. 13223  20 packages
 packed in foil 2 x 2 m

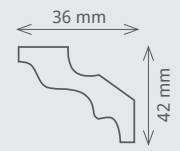

M 100 Art.-Nr. 13037  30 pieces
E 24 Art.-Nr. 13224  18 packages
 packed in foil 1 x 2 m

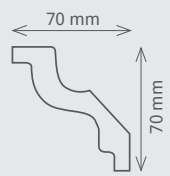

MT Art.-Nr. 13038  27 pieces

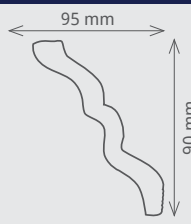

L = 2000 mm

A 3 Art.-Nr. 13015  300 pieces



L = 2000 mm

A 5 Art.-Nr. 13050  125 pieces



L = 2000 mm

A 7 Art.-Nr. 13051  72 pieces

E 51 Art.-Nr. 13251  18 packages packed in foil 2 x 2 m



L = 2000 mm

A 10 Art.-Nr. 13052  45 pieces



L = 2000 mm

K 35 Art.-Nr. 13009  150 pieces

E 10 Art.-Nr. 13210  40 packages packed in foil 2 x 2 m



L = 2000 mm

K 50 Art.-Nr. 13011  84 pieces

E 11 Art.-Nr. 13211  15 packages packed in foil 2 x 2 m



L = 2000 mm

K 60 Art.-Nr. 13034  40 pieces



L = 2000 mm

K 80 Art.-Nr. 13012  27 pieces

E 12 Art.-Nr. 13212  12 packages packed in foil 1 x 2 m



L = 2000 mm

K 130 Art.-Nr. 13039  22 pieces





L = 2000 mm

C 30 Art.-Nr. 13014  200 pieces



L = 2000 mm

C 40 Art.-Nr. 13010  120 pieces

E 15 Art.-Nr. 13215  35 packages
packed in foil 2 x 2 m



L = 2000 mm

C 50 Art.-Nr. 13013  80 pieces

E 16 Art.-Nr. 13216  24 packages
packed in foil 2 x 2 m

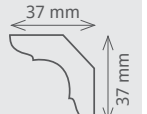

L = 2000 mm

C 70 Art.-Nr. 13030  45 pieces

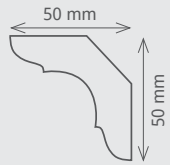

L = 2000 mm

C 100 Art.-Nr. 13031  35 pieces

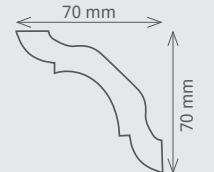

L = 2000 mm

AS Art.-Nr. 13053  35 pieces

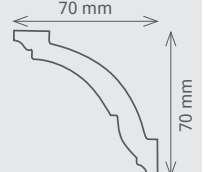

L = 2000 mm

T 30 Art.-Nr. 13083  150 pieces

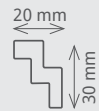

L = 2000 mm

T 70 Art.-Nr. 13082  40 pieces

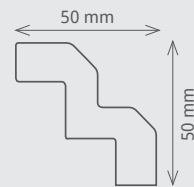



L = 2000 mm

D 20 Art.-Nr. 13020  175 pieces

E 20 Art.-Nr. 13220  40 packages
packed in foil 2 x 2 m



L = 2000 mm

D 25 Art.-Nr. 13025  200 pieces

E 21 Art.-Nr. 13221  40 packages
packed in foil 2 x 2 m



L = 2000 mm

HO Art.-Nr. 13047  60 pieces



L = 2000 mm

O 45 Art.-Nr. 13045  80 pieces

E 30 Art.-Nr. 13230  25 packages
packed in foil 2 x 2 m



L = 2000 mm

JO Art.-Nr. 13046  50 pieces



L = 2000 mm

FL 50 Art.-Nr. 13085  90 pieces





BI 20 Art.-Nr. 16220
 10 foil bags
 Set á 4 pieces

I 20 Art.-Nr. 13041
 250 pieces
 20 mm

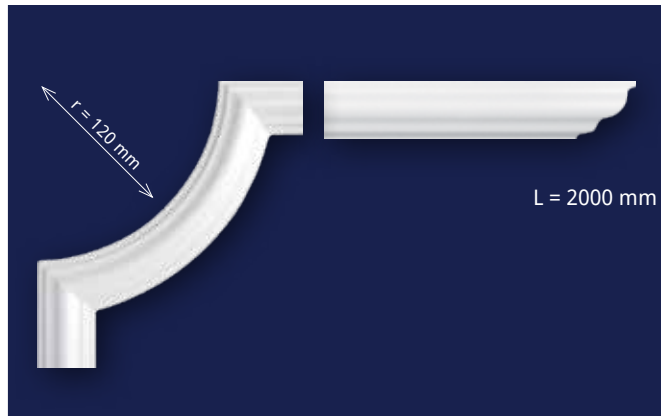

BI 40 Art.-Nr. 16241
 10 foil bags
 Set á 4 pieces

I 40 Art.-Nr. 13042
 120 pieces
 40 mm

E 36 Art.-Nr. 13236
 30 packages
 packed in foil 2 x 2 m

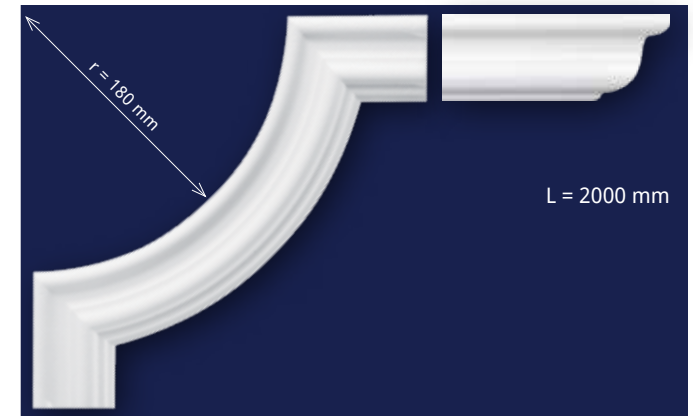

BI 60 Art.-Nr. 16243
 10 foil bags
 Set á 4 pieces

I 60 Art.-Nr. 13043
 60 pieces
 60 mm

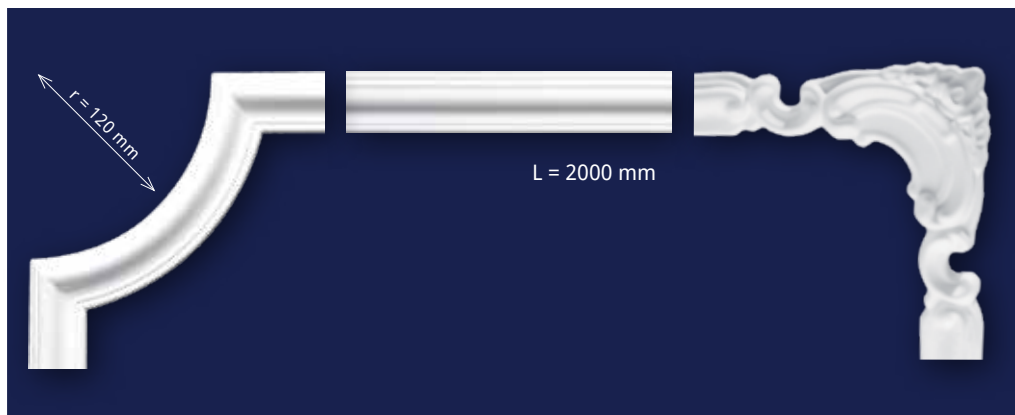

BU 40 Art.-Nr. 16240
 10 foil bags
 Set á 4 pieces

U 40 Art.-Nr. 13040
 100 pieces
 40 mm

E 40 Art.-Nr. 13240
 30 packages
 packed in foil 2 x 2 m

BU 40 D Art.-Nr. 16242
 10 foil bags
 Set á 4 pieces



Individuelle Gestaltungswünsche mit diesen dekorativen Alleskönnern realisieren

Produkteigenschaften:

- schlag-, stoß- und druckfeste Oberfläche
- verdeckte Kabelführung bei verschiedenen Modellen möglich
- überstreichbar mit allen lösungsmittelfreien Farben
- frei von Lösungsmitteln und FCKW, umweltfreundlich
- Klebverbrauch: ca. 30 g/m



Realize individual design wishes with these decorative allrounders

product features:

- impact, shock and pressure resistant surface
- concealed cable management in different models possible
- paintable with all solvent-free paints
- free from solvents and CFC, environmentally friendly
- consumption of glue: ca. 30 g/m

DE Wand- und Fußleisten aus HD-Polymer

GB Wall mouldings and skirtings made of HD-polymer

FR Cimaises et plinthes en polymère HD

ES Molduras de friso y ropapiés de polímero HD

IT Cornice et battiscopa in plastica alta densità

RU Настенные и напольные профили из высокопрочного полимера

PT Frisos de parede e rodapés produzidos em polímero

PL Listwy ścienne i podłogowe z polimeru - HD

CZ Nástěnné a podlahové lišty z HD-Polymeru

RS Zidne i podne lajsne od tvrdog polimera

HR Zidne letvice i sokl izrađeni od polimera visoke čvrstoće

RO Perete și șipci din polimer de rezistență ridicată

BG Стена и перваз на HD-Polymer

GR Επιτοίχια προφίλ και σοβατεπί από HD πολυμερές

SE Vägg och golvlister av hållbar polymer

AR قفاشكلا ؤيالاع تارم يلوبلا قدام نم ؤعونصملا تايزرألاو ناردجلا تاماع



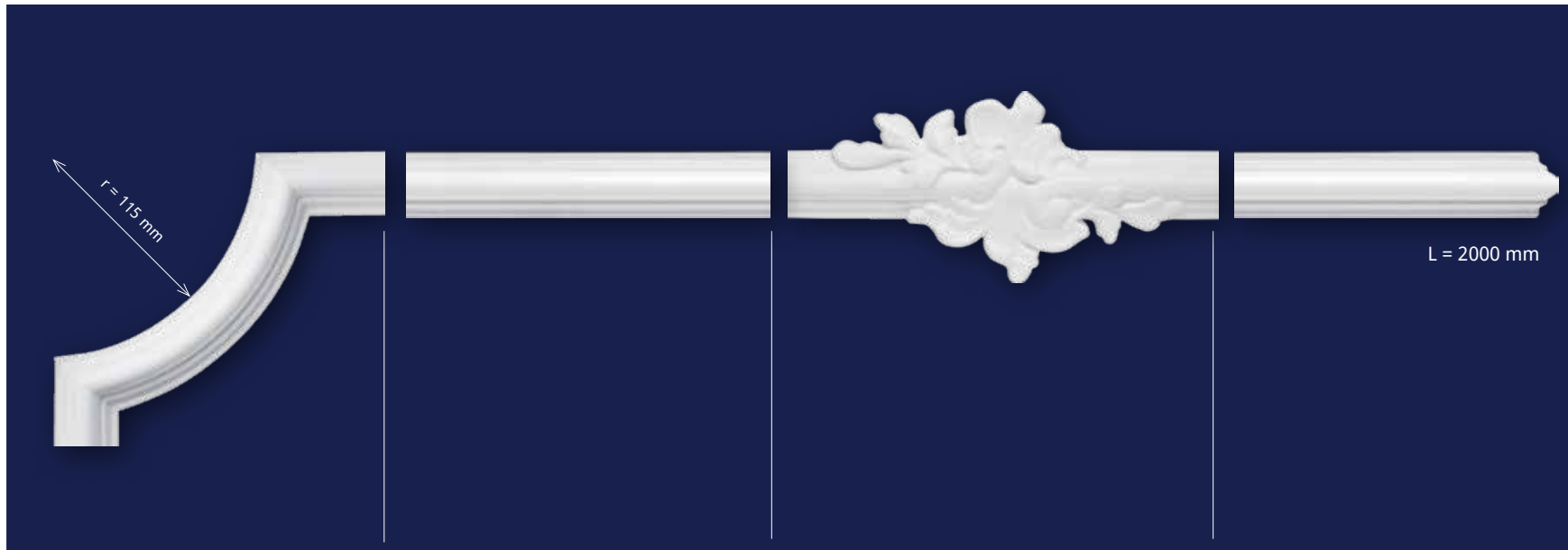

BW 11 Art.-Nr. 60020
 10 foil bags
 Set á 4 pieces

CW 11 Art.-Nr. 60001
 50 pieces
 Art.-Nr. 13709
 45 packages
 packed in foil 1 x 2 m

OW 11 Art.-Nr. 60021
 10 foil bags
 Set á 2 pieces



CW 10 Art.-Nr. 60000 100 pieces

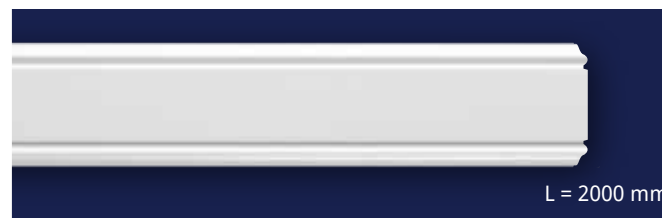

CW 12 Art.-Nr. 60002 40 pieces
 Art.-Nr. 13602 40 packages
 packed in foil 1 x 2 m

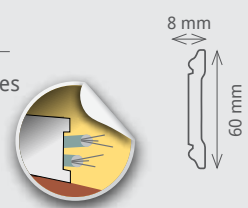

CW 13 Art.-Nr. 60003 20 pieces





L = 2000 mm

CU Art.-Nr. 61000  25 pieces





L = 2000 mm

CF 11 Art.-Nr. 61001  21 pieces

Art.-Nr.13611  21 packages
packed in foil 1 x 2 m



L = 2000 mm

CF 12 Art.-Nr. 61002  13 pieces

Art.-Nr.13612  10 packages
packed in foil 1 x 2 m





L = 2000 mm

CF 13 Art.-Nr. 61003  12 pieces





L = 2000 mm

CF 14 Art.-Nr. 61004  12 pieces





L = 2000 mm

CP 20 Art.-Nr. 62002  140 pieces



L = 2000 mm

CP 30 Art.-Nr. 62003  70 pieces





Verspielte Ornamente, pompöse Verzierungen
und luxuriöse Dekore schaffen bleibende Akzente

Produkteigenschaften:

- druckfest, sehr leicht und einfach zu verarbeiten
- passgenaue Profilkonturen, einwandfreier Anschluss von Wand zur Decke durch konstante Maße
- überstreichbar mit allen lösungsmittelfreien Farben
- schwer entflammbar nach DIN 4102
- frei von Lösungsmitteln und FCKW, umweltfreundlich
- Klebverbrauch: ca. 30 g/m

Playful and pompous ornaments as well
as luxurious patterns create lasting highlights

product features:

- pressure-resistant, very easy to handle
- tailor-profile contours, perfect connecting from wall to the ceiling by constant mass
- paintable with all solvent-free paints
- flame-retardant in accordance with DIN 4102
- free from solvents and CFC, environmentally friendly
- consumption of glue: ca. 30 g/m

DE Zierleisten aus expandiertem Polystyrol
GB Decorative mouldings made of expanded polystyrene
FR Moulures décoratives en polystyrène expansée
ES Perfiles de adorno en poliestireno expandido
IT Profili decorativi di polistirolo espanso
RU Профиль из вспененного полистирола
PT Sancas moldadas em poliestireno de alta densidade
PL Listwy dekoracyjne z ekspandowanego polistyrenu

CZ Ozdobné lišty z expandovaného polystyrenu
RS Dekorativna lajsna od ekspaniranog polistirola
HR Okrasna letvica od ekspaniranog polistirena
RO Profilul fascia din polistiren expandat
BG Декоративен перваз от експандиран полистирол
GR Κορνίζες από διογκωμένη πολυστερίνη
SE Dekorativa taklister av extruderad polystyrene
AR عسوجلا نيرتس يلوبلا نم ةعونصلما زيرافالا





L = 2000 mm

Fleur Art.-Nr. 24240  70 pieces

Art.-Nr. 13709  45 packages
packed in foil 1 x 2 m



L = 2000 mm

Cosa Art.-Nr. 24241  90 pieces

Art.-Nr. 13708  55 packages
packed in foil 1 x 2 m



L = 2000 mm

Elisa Art.-Nr. 24242  80 pieces

Art.-Nr. 13708  55 packages
packed in foil 1 x 2 m



L = 2000 mm

Pamella Art.-Nr. 24210  52 pieces

Art.-Nr. 13710  52 packages
packed in foil 1 x 2 m



L = 2000 mm

Anna Art.-Nr. 24213  36 pieces

Art.-Nr. 13715  36 packages
packed in foil 1 x 2 m





L = 2000 mm

Tanja Art.-Nr. 24215  44 pieces

Art.-Nr. 13713  44 packages
packed in foil 1 x 2 m

L = 2000 mm

Ines Art.-Nr. 24218  48 pieces

to combine with
rosette **Sarah**, page 24 

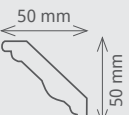

L = 2000 mm

Laura Art.-Nr. 24211  48 pieces

Art.-Nr. 13711  48 packages
packed in foil 1 x 2 m



L = 2000 mm

Helena Art.-Nr. 24216  54 pieces





L = 2000 mm

to combine with rosette **Gabi**, page 24

Lisa Art.-Nr. 24217  30 pieces

Art.-Nr. 13739  30 packages packed in foil 1 x 2 m



60 mm
70 mm



L = 2000 mm

Vera Art.-Nr. 24214  40 pieces

Art.-Nr. 13714  40 packages packed in foil 1 x 2 m



60 mm
70 mm



L = 2000 mm

Olga Art.-Nr. 24220  20 pieces

Art.-Nr. 13720  20 packages packed in foil 1 x 2 m



80 mm
80 mm



L = 2000 mm

Romy Art.-Nr. 24227  26 pieces

Art.-Nr. 13727  20 packages packed in foil 1 x 2 m



90 mm
90 mm



L = 2000 mm

Alla Art.-Nr. 24228  28 pieces



90 mm
90 mm



L = 2000 mm

Hella Art.-Nr. 24226  42 pieces

Art.-Nr. 13721  40 packages packed in foil 1 x 2 m



15 mm
80 mm



L = 2000 mm

Tina Art.-Nr. 24219  14 pieces

Art.-Nr. 13719  14 packages packed in foil 1 x 2 m



95 mm
95 mm



L = 2000 mm

Carmen Art.-Nr. 24221  12 pieces



95 mm
125 mm



L = 2000 mm

Selina Art.-Nr. 24222  20 pieces

Art.-Nr. 13741  20 packages packed in foil 1 x 2 m



60 mm
100 mm



L = 2000 mm

Katja Art.-Nr. 24237 15 pieces

95 mm

95 mm

L = 2000 mm

Sveta Art.-Nr. 24231 22 pieces

75 mm

130 mm

Art.-Nr. 13743 16 packages
packed in foil 1 x 2 m

L = 2000 mm

Andrea Art.-Nr. 24232 16 pieces

75 mm

130 mm

L = 2000 mm

Isabell Art.-Nr. 24235 16 pieces

80 mm

130 mm

Art.-Nr. 13742 11 packages
packed in foil 1 x 2 m



L = 2000 mm

Marie Art.-Nr. 24225  14 pieces

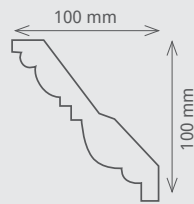

L = 2000 mm

Simone Art.-Nr. 24234  22 pieces

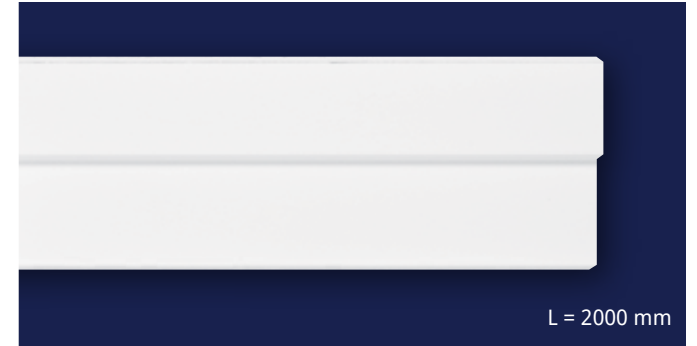
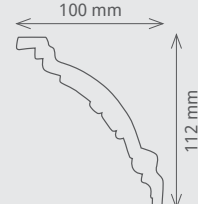

L = 2000 mm

NLA Art.-Nr. 24236  25 pieces

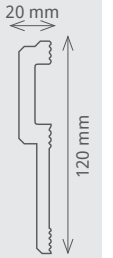



L = 2000 mm

Lena Art.-Nr. 24243  20 pieces

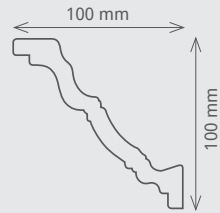

L = 2000 mm

Nina Art.-Nr. 24244  18 pieces

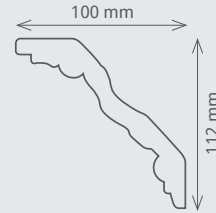

L = 2000 mm

Eva Art.-Nr. 24245  21 pieces

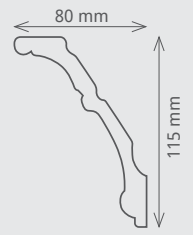

L = 2000 mm

Olivia Art.-Nr. 24246  20 pieces



L = 2000 mm

Zara Art.-Nr. 24247  18 pieces



L = 2000 mm

Amelia Art.-Nr. 24248  24 pieces

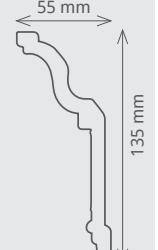

Lichtblicke für jeden Wohnraum – eine besondere Art der Raumbelichtung

Produkteigenschaften:

- Material: expandiertes oder extrudiertes Polystyrol (abhängig von der Zierleiste)
- Lichtleisten für indirekte Beleuchtung mit handelsüblichen LED-Streifen
- druckfest, sehr leicht und einfach zu verarbeiten
- präzise gearbeitete Formgebung
- überstreichbar mit allen lösungsmittelfreien Farben
- Temperaturbeständigkeit bis 60 °C
- frei von Lösungsmitteln und FCKW, umweltfreundlich
- Klebverbrauch: ca. 30 g/m

Bright spot for every living rooms – a special way of room illumination

product features:

- material: expanded or extruded polystyrene (depending on the moulding)
- decorative mouldings for indirect lighting with standard LED-strips
- pressure-resistant, very easy to handle
- high-precision shaped
- paintable with all solvent-free paints
- Temperature resistance: 60 °C
- free from solvents and CFC, environmentally friendly
- consumption of glue: ca. 30 g/m

DE Zierleisten für indirekte Beleuchtung
 GB Decorative mouldings for indirect lighting
 FR Moulures décoratives d'éclairage indirect
 ES Perfiles de adorno por la iluminación indirecta
 IT Profili decorativi per illuminazione indiretta
 RU Профиль для скрытого освещения
 PT Sancas para iluminação indireta
 PL Listwy dekoracyjne podświetleniowe

CZ Ozdobné lišty pro nepřímé osvětlení
 RS Dekorativna lajsna za indirektno osvetljenje (skrivač svetla)
 HR Ukrasna letvica za indirektnu rasvjetu
 RO Profilul fascia pentru iluminat indirect
 BG Декоративен перваз за непряко осветление
 GR Κορνιζές για κρυφό φωτισμό
 SE Lister för indirekt belysning
 AR قرش ابملا ريغ ءءاض اللى زي رافسا



LED

L = 2000 mm

Dana Art.-Nr. 24700  35 pieces



L = 2000 mm

L 45 Art.-Nr. 13080  65 pieces

Innenmaß / inner dimension: 26 mm



LED

L = 2000 mm

M 100 Art.-Nr. 13037  30 pieces

E 24 Art.-Nr. 13224  18 packages packed in foil 1 x 2 m



LED

L = 2000 mm

T 70 Art.-Nr. 13082  40 pieces



LED

L = 2000 mm

Viktoria Art.-Nr. 24239  18 pieces



Rosetten für Decke und Wand –
von eindrucksvoll pompös bis klassisch dezent

Produkteigenschaften:

- druckfest, sehr leicht und einfach zu verarbeiten
- präzise gearbeitete Formgebung
- überstreichbar mit allen lösungsmittelfreien Farben
- schwer entflammbar nach DIN 4102
- frei von Lösungsmitteln und FCKW, umweltfreundlich
- Klebverbrauch: ca. 30 g/Stück

Rosettes for ceilings and walls –
from impressively pompous to classically discreet

product features:

- pressure-resistant, very easy to handle
- precisely worked shaping
- paintable with all solvent-free paints
- flame-retardant in accordance with DIN 4102
- free from solvents and CFC, environmentally friendly
- consumption of glue: ca. 30 g/piece

DE Deckenrosette aus Polystyrol
GB Ceiling rosette of polystyrene
FR Rosace en polystyrène
ES Rosetone de poliestireno
IT Rosoni in polistirolo
RU Розетки из полистирола
PT Roseta de poliestireno
PL Rozety sufitowe z polistyrenu

CZ Stropní rozety z polystyrenu
RS Rozeta od polistirola
HR Rozeta izrađeni od polistirena
RO Rozeta izrađena od polistirena
BG Разетка столовая от полистирол
GR Ροζέτες οροφών από πολυστερίνη
SE Rosetter av polystyrene
AR نيرتس لوبلا تدام نم عونصم فسقسلل ةيفرخز ةيدرو ةيلح





Ø 280 mm

Julia Art.-Nr. 25206
 8 pieces

K 6 Art.-Nr. 15206
 8 pieces



Ø 300 mm

Diana Art.-Nr. 25208
 8 pieces



Ø 330 mm

K 9 Art.-Nr. 15209
 8 pieces



Ø 320 mm

K 11 Art.-Nr. 15211
 8 pieces



Ø 340 mm

Gracia Art.-Nr. 25265
 8 pieces



320 x 320 mm

Heike Art.-Nr. 25212
 10 pieces



Ø 370 mm

Rosa Art.-Nr. 25210
 8 pieces



Ø 370 mm

Carla Art.-Nr. 25211
 8 pieces

K 12 Art.-Nr. 15212
 8 pieces



Ø 370 mm

Mira Art.-Nr. 25213
 9 pieces

Alle Rosetten mit Mädchennamen besitzen eine plastifizierte Oberfläche. / Important note: All rosettes with girl names have a plastificated surface.



Alle Rosetten mit Mädchennamen besitzen eine plastifizierte Oberfläche. / Important note: All rosettes with girl names have a plastificated surface.



Pilaster aus Polystyrol –
unverwechselbare Akzente
für ein einzigartiges Wohnambiente

Produkteigenschaften:

- druckfest, sehr einfach montierbar
- sehr maßhaltig
- überstreichbar mit allen lösungsmittelfreien Farben
- frei von Lösungsmitteln und FCKW, umweltfreundlich

Pilasters made of polystyrene –
unique accents for an exclusive living ambience

product features:

- pressure-resistant, easy to install
- very true to size
- paintable with all solvent-free paints
- free from solvents and CFC, environmentally friendly

DE Pilaster aus Polystyrol
GB Pilaster of polystyrene
FR Pilastres en polystyrène
ES Pilastras de poliestireno
IT Pilastrini in polistirolo
RU Пилястра из полистирола
PT Pilastres em poliestireno
PL Pilaster z polistyrenu

CZ Pilastry z polystyrenu
RS Pilastrri od polistirola
HR Pilastrri izrađeni od polistirena
RO Pilastrri din polistiren
BG Пиластр от полистирол
GR Επιτοίχιες κολώνες από πολυστερίνη
SE Pilastrar av polystyren
AR نيريتس يلوبل ا قدام نم ةعونصم لاء ةيرادجلا تام اعدلا



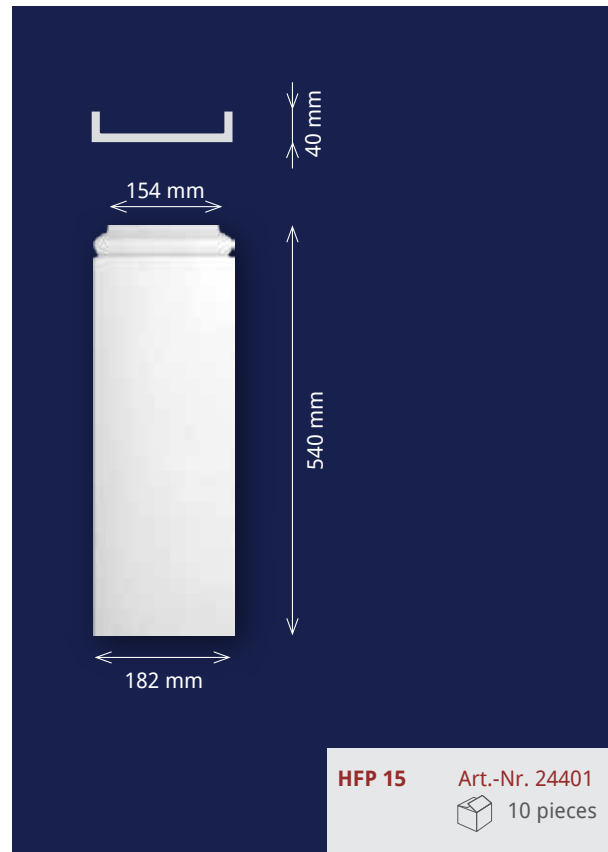
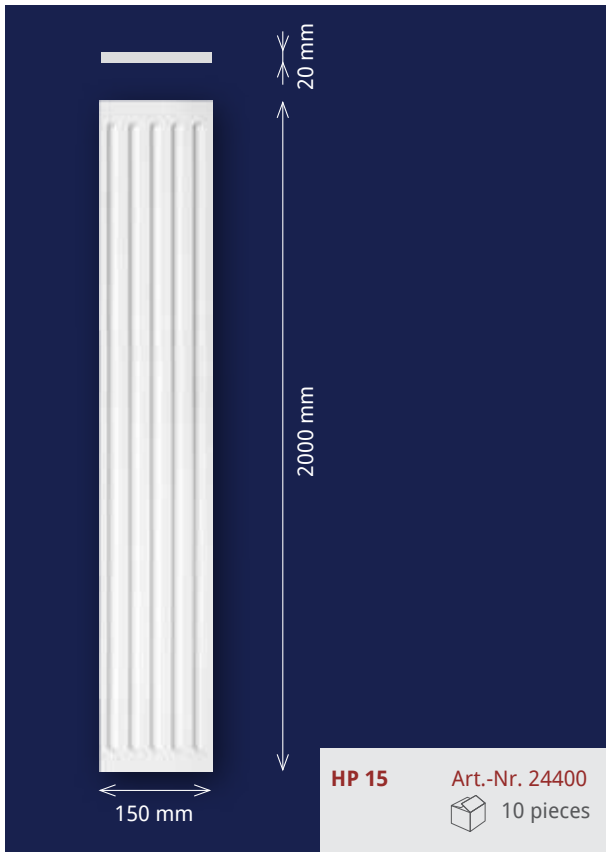
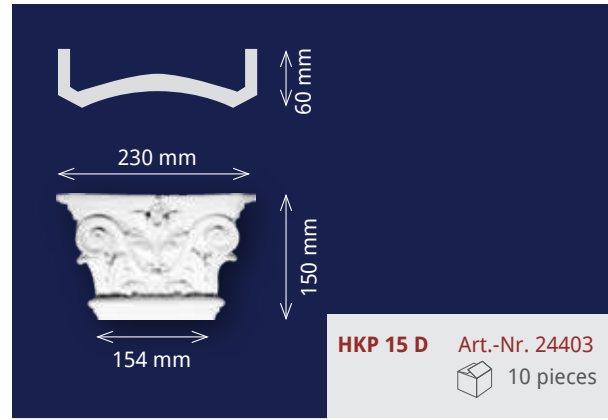
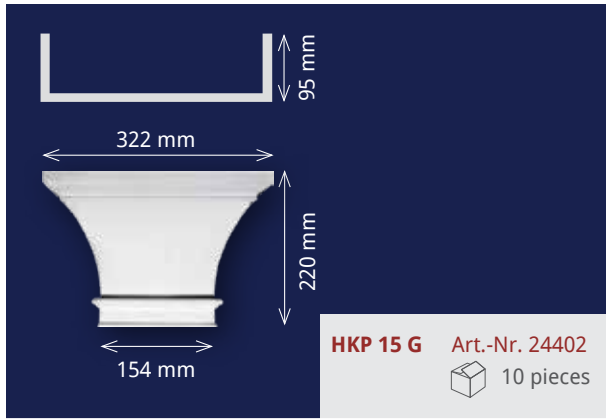

Säulen & Halbsäulen

Antikes Flair oder prächtige Moderne –
Säulen und Halbsäulen bilden ideale Stilmittel

Produkteigenschaften:

- druckfest, sehr leicht und einfach zu verarbeiten
- sehr maßhaltig
- flexible Zuschnitte möglich
- überstreichbar mit allen lösungsmittelfreien Farben
- frei von Lösungsmitteln und FCKW, umweltfreundlich
- Nicht als tragende Elemente einsetzbar!

Antique flair or magnificent modernity –
columns and half columns make
ideal stylistic devices

product features:

- pressure-resistant, easy to install
- very true to size
- Can be shortened individually in a flexible way with a fine saw.
- paintable with all solvent-free paints
- free from solvents and CFC, environmentally friendly
- Do not use as load-bearing elements!

DE Säulen und Halbsäulen aus Polystyrol
GB Columns and half columns of polystyrene
FR Colonnes et demi-colonnes en polystyrène
ES Columnas y medias columnas de poliestireno
IT Colonne e mezze colonne in polistirolo
RU Колонны и полуколонны из полистирола
PT Colunas e medias colunas em poliestireno
PL Kolumny i półkolumny z polistyrenu

CZ Sloupy a polosloupy z polystyrenu
RS Stubovi i polustubovi od polistirola
HR Stupovi i polu stupovi izrađeni od polistirena
RO Coloane și jumătăți de coloane din polistiren
BG Колони и колони половина от полистирол
GR Κολώνες και ημικολώνες από πολυστερίνη
SE Pelare och halva pelare av polystren
AR نيرتسي لوبلا قدام نم عونصلما ةيفصلنلا قدامعألا و قدامعألا





Kapitell D1
Art.-Nr. 24434
2,5 pieces



Kapitell D2
Art.-Nr. 24435
3 pieces



Kapitell G
Art.-Nr. 24433
2,5 pieces

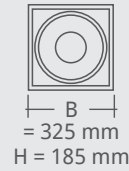

HS 22 R Art.-Nr. 24430 3 pieces

Ø = 220 mm
H = 835 mm

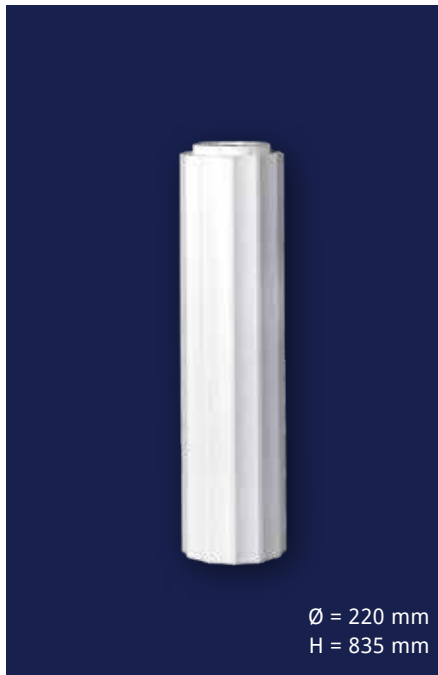

HS 22 K Art.-Nr. 24431 3 pieces

Ø = 220 mm
H = 835 mm



HS 22 F Art.-Nr. 24432 3 pieces

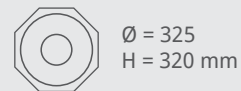

Gestaltungsbeispiele
Design Examples

Kapitell D2
+ 3 x HS 22 K
+ HS 22 F
H = 3130 mm



Kapitell G
+ 2 x HS 22 R
+ HS 22 F
H = 2175 mm



Kapitell D2
+ HS 22 K
+ HS 22 F
H = 1460 mm

Kapitell D1
+ HS 22 R
+ Kapitell G
H = 1150 mm





Kapitell D1/H

Art.-Nr. 24440

5 pieces

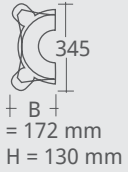

Kapitell D2/H

Art.-Nr. 24441

6 pieces

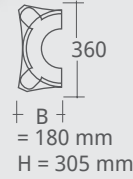

Kapitell G/H

Art.-Nr. 24439

5 pieces

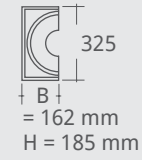

Ø = 220 mm
H = 835 mm

HS 22 R/H Art.-Nr. 24436 6 pieces



Ø = 220 mm
H = 835 mm

HS 22 K/H Art.-Nr. 24437 6 pieces

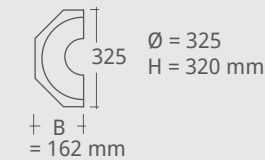

HS 22 F/H
Art.-Nr. 24438

6 pieces

Ø = 325
H = 320 mm



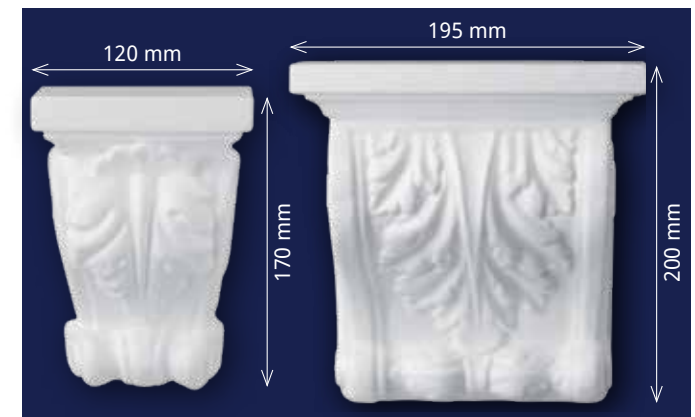

Konsole Alina

Art.-Nr. 24600

6 pieces

B x H x T

120 x 170 x 70 mm

Konsole Melina

Art.-Nr. 24601

4 pieces

B x H x T

195 x 200 x 100 mm

Verblendsteine

Verblendsteine aus Polystyrol – neue gestalterische Freiräume für Individualisten

Produkteigenschaften:

- druckfest, sehr leicht und einfach zu verarbeiten
- naturgetreue Nachbildung einer Steinoberfläche
- einfache, zügige und fugenlose Anbringung mit dem HOMESTAR SX 20 und SX 100 Styroporkleber (Kleerverbrauch: ca. 250 g/m²)
- vielfältige Gestaltungsmöglichkeiten mit lösungsmittelfreier Farbe oder Feinputz und ggf. Farbauftrag mit Kreativtechniken
- schwer entflammbar nach DIN 4102
- frei von Lösungsmitteln und FCKW, umweltfreundlich

Facing bricks of polystyrene – new creative scopes for individualists

product features:

- pressure-resistant, easy to install
- lifelike replica of a stone surface
- simple, quick and seamless attachment to the HOMESTAR SX 20 and SX 100 styrofoam glue or with solvent-free universal adhesive (consumption of glue: ca. 250 g/m²)
- flame-retardant in accordance with DIN 4102
- a variety of design possibilities with solvent-free paint with various creative techniques and fine plaster

- DE Verblendsteine aus Polystyrol
- GB Facing bricks of polystyrene
- FR Pierre de parement en polystyrène
- ES Piedra decorativa de poliestireno
- IT Pietra da rivestimento in polistirolo
- RU Облицовочный камень из полистирола
- PT Imitação de pedra feita em poliestireno
- PL Kamień dekoracyjny z polistyrenu

- CZ Obkladové kameny z polystyrenu
- RS Imitacija dekorativne cigle od polistirola
- HR Imitacija kamena od polistirena
- RO Imitație piatra din polistiren
- BG Имитация на каменна от полистирол
- GR Διακοσμητικές πέτρες από πολυστερίνη
- SE Dekostenar gjord av polystyrene
- AR نيريسس يلوبيل اقام نم عونصملا يفرخزلا بوظلا





500 x 200 mm

Ambiente Art.-Nr. 24500  7 packages
 Inhalt pro Pack: 10 Stück = 1 m²
 content per package: 10 pieces = 1 m²



Collection

Balken & Bretter

Pures Wohlempfinden mit einem Hauch
von mediterran-ländlichem Ambiente
im eigenen Zuhause

Produkteigenschaften:

- originalgetreue Nachbildung einer natürlichen Holzoptik
- widerstandsfähige und glatte Oberfläche
- flexibles Kürzen möglich
- bereits gestrichen geliefert aber zusätzlich überstreichbar mit allen lösungsmittelfreien Farben
- frei von Lösungsmitteln und FCKW, umweltfreundlich
- Klebverbrauch: ca. 50 g/m

Pure well-being with a touch
of mediterranean-rustic atmosphere
in your own home

product features:

- faithful replica of a natural wood look
- durable and smooth surface
- shorten flexible possible
- already painted delivered but also paintable with all solvent-free paints
- free from solvents and CFC, environmentally friendly
- consumption of glue: ca. 50 g/m

DE Balken und Bretter aus Polyurethan
GB Beams and boards of polyurethane
FR Poutres et planches en polyuréthane
ES Vigas y tablas de poliuretano
IT Travi e pannelli in poliuretano
RU Балки и доски из полиуретана
PT Vigas e tábuas de poliuretano
PL Belki i deski z poliuretanu

CZ Imitace dřevěných trámů z polyuretanu
RS Tramovi in deske iz poliuretana
HR Grede i daske od poliuretana
RO Grinzi si scanduri din poliuretán
BG Греди и дъски, изработени от полиуретан
GR Δοκοί και σανίδες από πολυουρεθάνη
SE Takbjälkar och plankor av polyuretan
AR ناثي روي ييلوبالما قدام نم ةعونصملا حاولأل او تاماعد





2600 x 130 x 30 mm

Brett Eiche dunkel Art.-Nr. 19300  16 pieces
Board oak dark



2600 x 130 x 30 mm

Brett Eiche hell Art.-Nr. 19350  16 pieces
Board oak light





2600 x 130 x 30 mm



Brett weiß Art.-Nr. 19400  16 pieces
Board white





Eiche dunkel / Beam oak dark 2 m

- 90 x 60 mm Art.-Nr. 19500  10 pieces
- 120 x 120 mm Art.-Nr. 19510  4 pieces
- 200 x 130 mm Art.-Nr. 19520  2 pieces

Eiche dunkel / Beam oak dark 3 m



- 90 x 60 mm Art.-Nr. 19502  10 pieces
- 120 x 120 mm Art.-Nr. 19512  4 pieces
- 200 x 130 mm Art.-Nr. 19522  2 pieces
- 190 x 170 mm Art.-Nr.: 19523  2 pieces

Eiche dunkel / Beam oak dark 4 m





- 90 x 60 mm Art.-Nr. 19504  10 pieces
- 120 x 120 mm Art.-Nr. 19514  4 pieces
- 200 x 130 mm Art.-Nr. 19524  2 pieces
- 190 x 170 mm Art.-Nr. 19525  2 pieces







Eiche hell / Beam oak light 2 m

- 90 x 60 mm Art.-Nr. 19550  10 pieces
- 120 x 120 mm Art.-Nr. 19560  4 pieces
- 200 x 130 mm Art.-Nr. 19570  2 pieces

Eiche hell / Beam oak light 3 m

- 90 x 60 mm Art.-Nr. 19552  10 pieces
- 120 x 120 mm Art.-Nr. 19562  4 pieces
- 200 x 130 mm Art.-Nr. 19572  2 pieces
- 190 x 170 mm Art.-Nr. 19573  2 pieces

Eiche hell / Beam oak light 4 m

- 90 x 60 mm Art.-Nr. 19554  10 pieces
- 120 x 120 mm Art.-Nr. 19564  4 pieces
- 200 x 130 mm Art.-Nr. 19574  2 pieces
- 190 x 170 mm Art.-Nr. 19575  2 pieces



Balken weiß / Beam white 2 m

- 90 x 60 mm Art.-Nr. 19600  10 pieces
- 120 x 120 mm Art.-Nr. 19610  4 pieces
- 200 x 130 mm Art.-Nr. 19620  2 pieces

Balken weiß / Beam white 3 m

- 90 x 60 mm Art.-Nr. 19602  10 pieces
- 120 x 120 mm Art.-Nr. 19612  4 pieces
- 200 x 130 mm Art.-Nr. 19622  2 pieces
- 190 x 170 mm Art.-Nr. 19623  2 pieces

Balken weiß / Beam white 4 m

- 90 x 60 mm Art.-Nr. 19604  10 pieces
- 120 x 120 mm Art.-Nr. 19614  4 pieces
- 200 x 130 mm Art.-Nr. 19624  2 pieces
- 190 x 170 mm Art.-Nr. 19625  2 pieces



Size in mm / ca.

90 x 60 mm

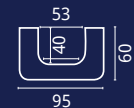

120 x 120 mm

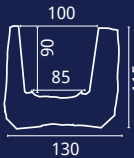

190 x 170 mm

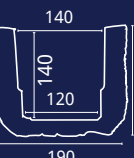

200 x 130 mm

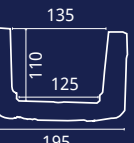

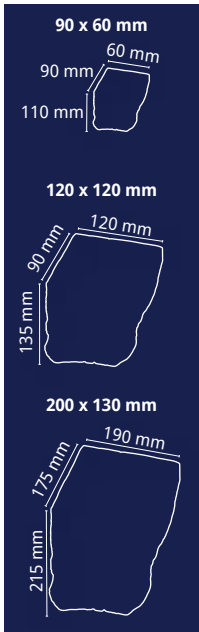

Konsole Eiche dunkel / Console oak dark

- 90 x 60 mm Art.-Nr. 19580  8 pieces
- 120 x 120 mm Art.-Nr. 19582  8 pieces
- 200 x 130 mm* Art.-Nr. 19584  4 pieces

* can combine with beam size 190 x 170 mm too



Konsole Eiche hell / Console oak light

- 90 x 60 mm Art.-Nr. 19586  8 pieces
- 120 x 120 mm Art.-Nr. 19588  8 pieces
- 200 x 130 mm* Art.-Nr. 19590  4 pieces

* can combine with beam size 190 x 170 mm too



Konsole weiß / Console white

- 90 x 60 mm Art.-Nr. 19680  8 pieces
- 120 x 120 mm Art.-Nr. 19682  8 pieces
- 200 x 130 mm* Art.-Nr. 19684  4 pieces

* can combine with beam size 190 x 170 mm too





Balkenbeschlag / fitting for beams 95 x 4 cm

- Art.-Nr. 19100  9 pieces



Beize / mordant 100 ml

- Eiche dunkel / oak dark Art.-Nr. 19110  6 pieces
- Eiche hell / oak light Art.-Nr. 19112  6 pieces
- weiß / white Art.-Nr. 19114  6 pieces



Deckenplatten

Attraktive Gestaltung von
Wohn- und Gewerberäumen zu kleinem Preis

Produkteigenschaften:

- schwer entflammbar nach DIN 4102
- druckfest, sehr leicht und einfach zu verarbeiten
- überstreichbar mit allen lösungsmittelfreien Farben
- frei von Lösungsmitteln und FCKW, umweltfreundlich
- Klebverbrauch: ca. 250 g/m²

Attractive design of
residential and commercial spaces for a small price

product features:

- flame-retardant in accordance with DIN 4102
- pressure-resistant, very easy to handle
- paintable with all solvent-free paints
- free from solvents and CFC, environmentally friendly
- consumption of glue: ca. 250 g/m²

- DE** Deckenplatten aus Polystyrol
GB Ceiling tiles of polystyrene
FR Dalles de plafond en polystyrène
ES Paneles de techo de poliestireno
IT Pannelli del soffitto in polistirolo
RU Потолочные плитки из полистирола
PT Painéis de teto em poliestireno
PL Kasetony sufitowe z polistyrenu

- CZ** Stropní kazety z polystyrenu
RS Plafonske obloge od polistirola
HR Stropne ploče od polistirena
RO Panouri de plafon din polistiren
BG Пана за таван от полистирол
GR Πλάκες οροφής από πολυστερίνη
SE Takpaneler av polystyren
AR نيرتس يلوبال قدام نم ةعونصم لافسلس لانتاحول



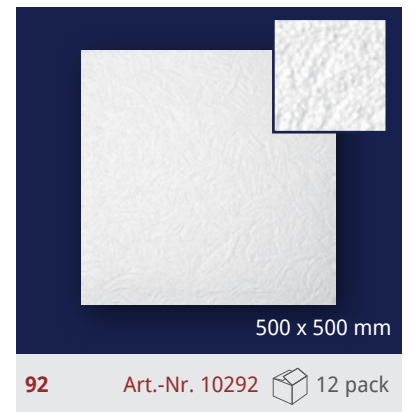

Inhalt pro Pack: 2 m² / content per package: 2 m²

Dämmtapeten

Dämmmaterialien für die Innenräume –
geringere Energiekosten bei gleichzeitigem
Schutz der Umwelt

Produkteigenschaften:

- glatte Oberfläche als Tapezieruntergrund
- Ausgleich von Unebenheiten und Abdeckung von Rissen
- Reduzierung des Wärmeverlustes durch die Wand um bis zu 16 %*
- einfache Verarbeitung mit lösemittelfreiem Styroporkleber (Kleberverbrauch: 250 - 500 g/m²)

* im Verhältnis zu einem ungedämmten, 24 cm starken Ziegelmauerwerk

Insulation materials for the interiors –
lower energy costs while protecting
the environment

product features:

- smooth paper surface as base for wallpaper
- compensation of bumps and cracks cover
- reduces heat loss through the wall by up to 16 %
- easy wall application with solvent-free glue for Styrofoam (consumption of glue: ca. 250 - 500 gm²)

* in relation to an uninsulated, 24 cm thick brickwork

DE Dämmtapeten für Innenwände
GB Insulation wallpaper for interior walls
FR Papier peint isolant pour cloisons intérieures
ES Papel aislante para paredes interiores
IT Carta da parati isolante per pareti interne
RU Изоляция обои для внутренних стен
PT Isolamento papel de parede para paredes interiores
PL Tapety izolacyjne do wewnątrz

CZ Izolační tapety do interiéru
RS Izolacija za unutrašnje zidove
HR Izolacijske zidne tapete
RO Tapet izolant pentru pereti interiori
BG Изолация тапет за вътрешни стени
GR Μονωτικές ταπετσαρίες για εσωτερικούς τοίχους
SE Bakgrund för isolering av polystyrene
AR ةيلخ ادلا نار دجلد قزار حلدل لزااعلا طئ احلا قرو



**Dämmtapete unkaschiert /
Insulation wallpaper
non-laminated for interior walls**

Art.-Nr. 40211  12 pieces



**Dämmtapete mit Pappe kaschiert /
Laminated insulation wallpaper
(pasteboard) for interior walls**

Art.-Nr. 40212  12 pieces

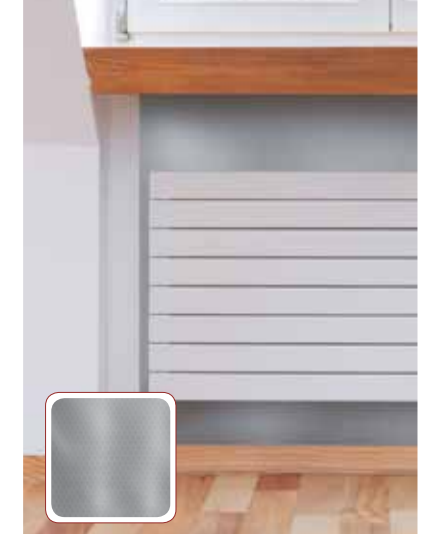

**Heizkörper-Reflexionsfolie /
Reflecting foil for radiator**

Art.-Nr. 40221  12 pieces

Zubehör

DE Montagezubehör
GB Installation accessories
FR Accessoires de pose
ES Accesorios de montaje
IT Accessori di montaggio
RU Монтажные аксессуары
PT Acessórios de montagem
PL Tapety izolacyjne do wewnętrz

CZ Příslušenství
RS Montažni pribor
HR Montažni pribor
RO Accesorii de montaj
BG Монтажни аксесоари
GR Βοηθητικά τοποθέτησης
SE Monteringsstillbehör
AR بي كرتليل قلاب القاشاق حليملاو تاشاي لامكلا



Schneidelehre / cutting guide EPS
 Art.-Nr. 30001  6 pieces

Styroporsäge / hand saw
 Art.-Nr. 30021  6 pieces



Montagekleber SX 100, 250 g Tube / adhesive SX 100, 250 g tube
 Art.-Nr. 50024  15 pieces



Montagekleber SX 100, 400 g Kartusche / adhesive SX 100 cartridge
 Art.-Nr. 50021  15 cartridges



Spachtelkleber SX 20, 1,5 kg / adhesive SX 20, 1,5 kg
 Art.-Nr. 50003  9 buckets



Spachtelkleber SX 20, 4 kg / adhesive SX 20, 4 kg
 Art.-Nr. 50002  1 bucket

Verarbeiten, Verkleben und Verzieren
leicht gemacht

Produkteigenschaften:

- Kleber für Montage von Styroporprodukten
- Hilfsmittel für Zuschnitt
- frei von Lösungsmitteln und FCKW, umweltfreundlich

Processing, gluing and decorating made easy

product features:

- Glue for installation of polystyrene products
- tools for cutting
- free from solvents and CFC, environmentally friendly

Marketing

www.homestar-shop.com

attraktive Produktverpackung / attractive product packaging

internationaler Katalog / international catalogue



hochauflösendes Bildmaterial für Print- und Onlinewerbung / for high resolution images print and online advertising



Anna

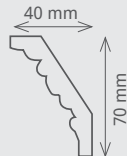

PR- und Öffentlichkeitsarbeit / Public Relations



Produktmuster für den Verkaufsraum Product Samples for the salesroom



internationaler Unternehmensauftritt online / international company website

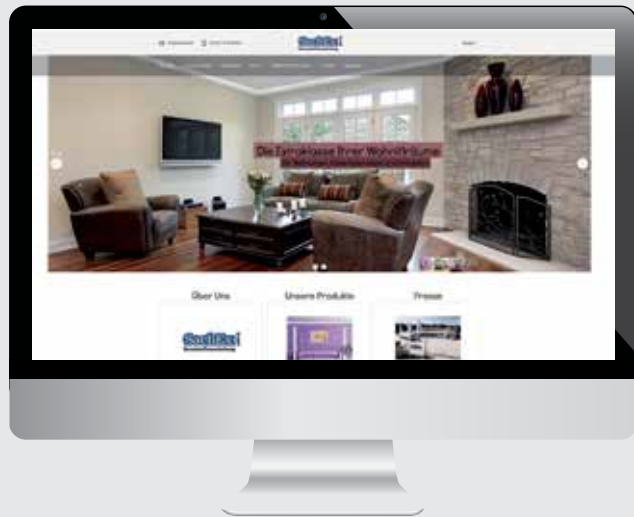

www.sachex.com

viele Informationen zu Produkten
mit Kreativbeispielen

much product information
with application examples

Regalpräsentation am POS Shelf presentation at the POS





Das Synonym für exklusive Raumgestaltung /
The synonym for luxury interior design

